



Installation and Care
Meyco Safety Pool Covers

Pool Owner		Order #	
Pool Dealer			
Pool Size		Cover Size	
Overlap	Anchors		Date Installed

HEADQUARTERS

MEYCO PRODUCTS, INC.
1225 Walt Whitman Road
Melville, NY 11747

SOUTHERN OPERATIONS

MEYCO PRODUCTS, INC.
846 W.O. Ezell Blvd.
Spartanburg, SC 29301

(631) 421-9800
(800) 446-3926
Fax: (631) 421-8621

READ MANUAL COMPLETELY BEFORE INSTALLING COVER.

Equipment Required for Installation

HARDWARE PACKED WITH YOUR COVER:

1. BRASS ANCHORS - ONE FOR EACH COVER STRAP



Optional Pop-Up Anchor



Screw Type Anchor

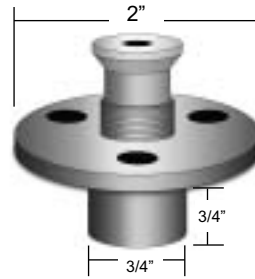

Wood Deck Anchor

2. STAINLESS STEEL COMPRESSION SPRINGS - ONE FOR EACH STRAP



3. ANCHOR TAMPING TOOL - USED TO TAMP ANCHORS INTO DECK



For Pop-Up Style Anchors



For Screw-Type Anchors

4. INSTALLATION ROD - FOR ATTACHING AND REMOVING COVER



5. HEX KEY - TO ROTATE ANCHOR INSERT TO UP OR DOWN POSITION



FOR LIMITED DECKING:

1. O-RING



2. SHORT SPRING



note: replacement covers are shipped without anchors, springs, or tamping tool unless requested when the cover is ordered. An allowance has been made in the cover's cost for anchors and springs not ordered with the cover

note: hardware type and quantities shipped with your cover may be adjusted to fit your particular pool and decking requirements.

WHAT YOU WILL NEED:

1. **Rotary hammer drill** - this may be purchased from many hardware stores or rented from a tool rental shop. Common manufacturers are Bosch, Skil, Hilti, and Black & Decker.
2. **3/4" drill bit** - carbide tipped are normally used. Diamond tipped bits are available for longer life and more precisely round holes.
3. **Hammer or mallet**
4. **Tape measure**
5. **Chalk**
6. **Chalk line** - to help line up anchor locations
7. **Lubricant** - a light oil or silicone spray
8. **Buckets** (see page 7)

note: Installation into other than normal concrete decking may require optional or additional hardware and installation tools. Refer to pages 12-15 in this booklet for information on optional hardware installation.

Table of Contents

Equipment Requirements for Installation2

Positioning the Cover4

Installing Covers (Rectangular).....5

Alternative Method of Installation (Rectangular).....6

Installing Covers (Odd Shapes)7-8

Anchor Drilling.....9

Fastening Springs to Anchors10

Removing Springs from Anchors.....11

Hardware12-15

Use and Care Instructions16

Positioning Cover:

Remove all ladders and rails not permanently anchored into the decking. Unroll the cover off the side of the pool (if decking permits). **Be careful not to drag or snag it on any obstructions or the decking.** Be sure that the reinforcing strips sewn under each strap around the cover perimeter are facing down towards the pool or coping edge. The Meyco cautionary label should be facing up. Carefully rotate the cover, if necessary, to properly position the cover over the pool. If there are any cutouts for obstructions on the cover, these areas of the cover must be positioned and installed first.

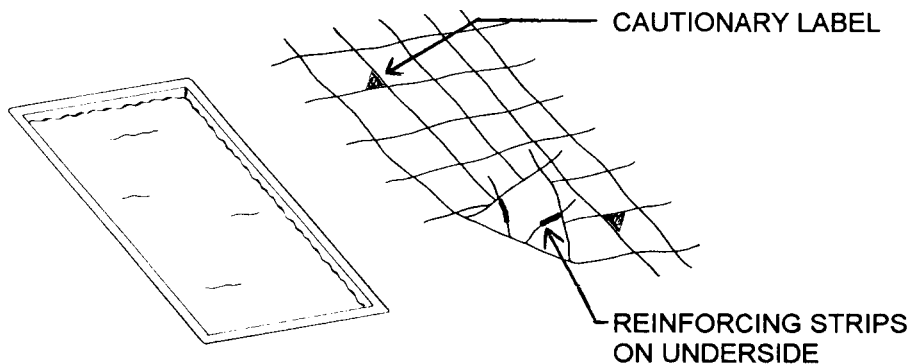

The cover should now be sagging into the pool with the material floating on the water. Attach all springs to straps by threading the strap through the spring and back through the buckle on the strap. Use the following diagram as a guide. Position the spring to be about 10" from the cover's edge - adjustments can be made in positioning later if needed.

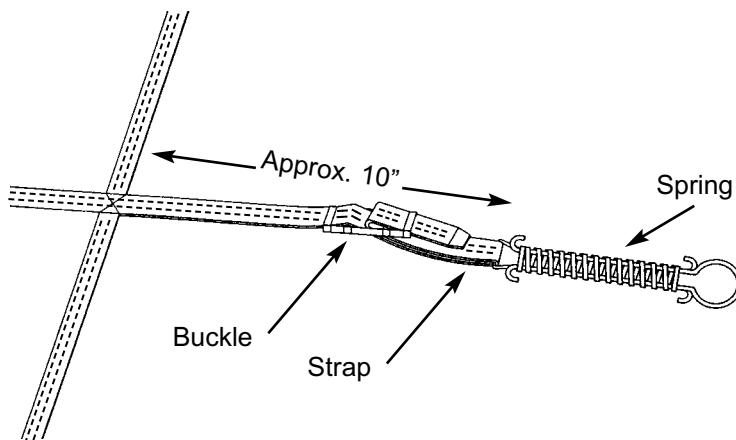

Installing Covers:

Standard & Custom - Rectangular Covers

(look for orientation label on cover to coincide with anchor plan)

Start by anchoring both ends of a center strap (A&B) down lengthwise. (Follow the anchor drilling instructions on page 9.) Then install both ends of a center strap (C&D) across the pool width. Be sure there is an equal overlap on both sides and ends. For the proper overlap look at the first page of this booklet, or subtract the pool size from the cover size and divide by two. Anchors should be located 20" back from the cover's edge. The correct anchor distance back from the pool edge is the core overlap plus this 20". Typically the anchors are about 32" to 38" back from the pool edge.

INSTALL CENTER STRAP A-B

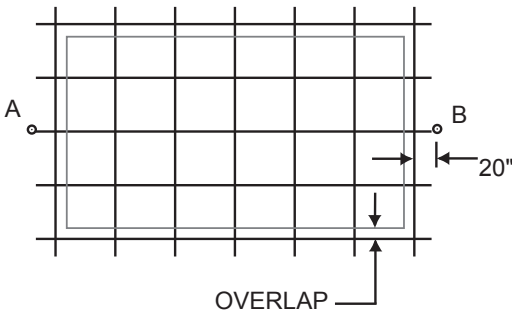

INSTALL CROSS STRAP C-D

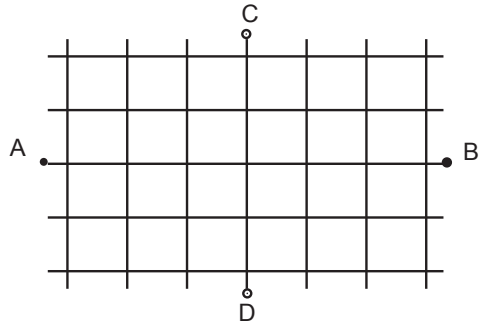

The installation can be completed by installing remaining anchors towards corners.

INSTALL REMAINING ANCHORS

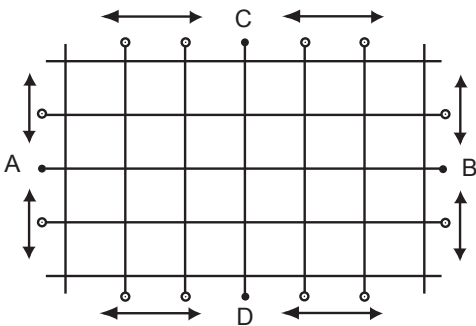

INSTALL CORNER ANCHORS

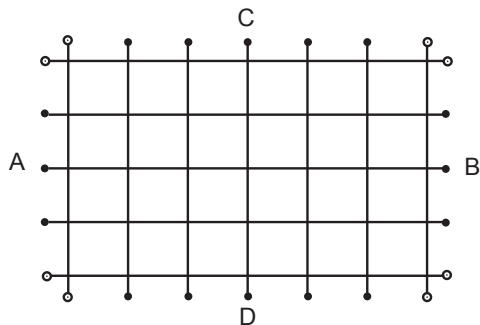

Alternative Rectangular Method

Rectangular covers may also be installed by anchoring the corners first. When using this method, it is advisable to mark the cover corner locations on the deck in chalk. Then mark the corner anchor locations by measuring 20" out from the cover corner and slightly (2") away from the center of the pool to allow for eventual cover stretch.

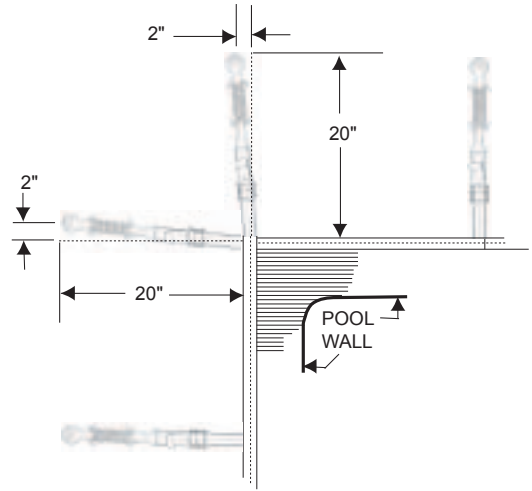
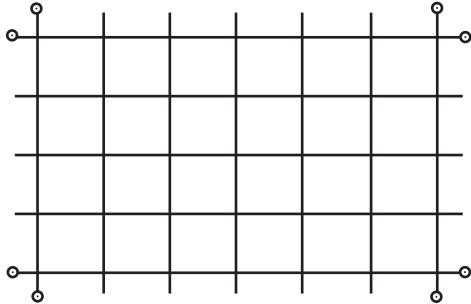

When all eight corner anchors are installed, adjust the strap through the buckles for proper tension and equal overlap. Using a chalk line or piece of string, mark a straight line between corner anchors on all four sides of deck. Install remaining anchors down the length of pool, being sure to locate the anchor on the chalk line and pulling the cover strap straight out from the cover. Continue to do the same down the width sides of the pool. Straps and buckles can be adjusted to alleviate straps not in perfect alignment.

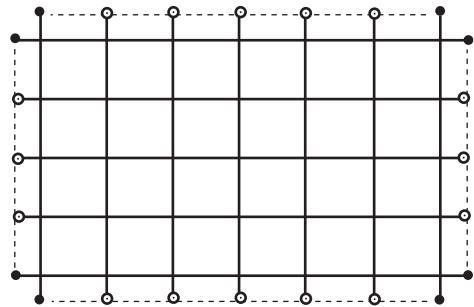
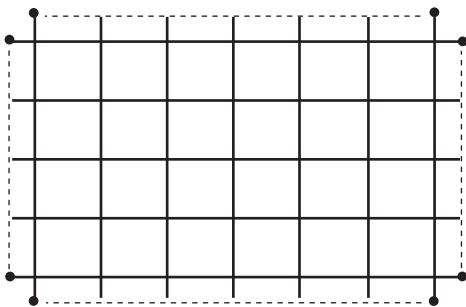

Installing Covers:

Custom Plus - Odd Shaped Covers

A number of water-filled containers or similar weights should be positioned on some of the straps to hold the cover in position. **Be careful not to position weights directly on the cover material as it could snag or damage the material.** If there are any obstructions, first, position the cover so that cutouts fit around obstructions (e.g. rocks, rails, raised walls).

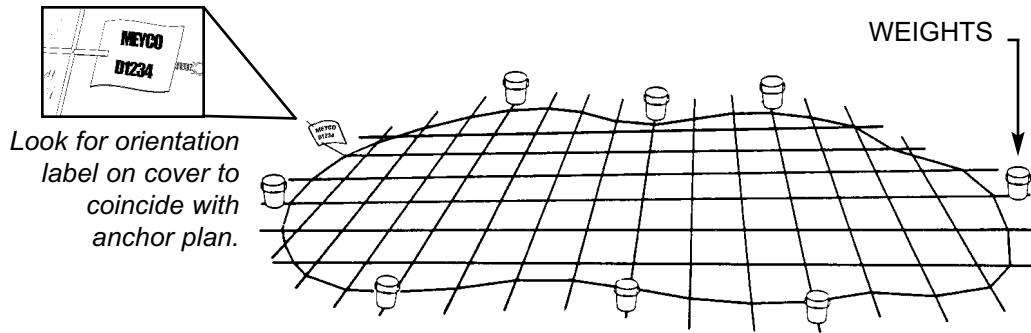

Start by anchoring both ends of a center strap (A&B) down lengthwise. Follow the anchor drilling instructions in this booklet. Then install both ends of a center strap (C&D) across the pool width. Be sure there is an equal overlap around the pool. For the proper overlap look at the first page of this booklet, or subtract the pool size from the cover size and divide by 2. Check to be sure the anchors are the proper distance back from the edge of the pool. Anchors should be located 20" back from the cover's edge.

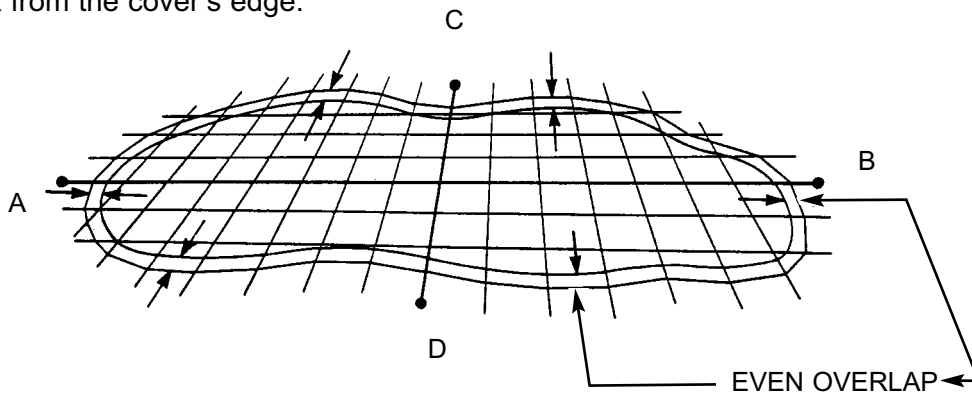

Continue to install the remaining anchors being sure to pull the straps out straight from the cover. Set anchors back to proper distance from the pool edge. Anchors should be located 20" from the cover's edge. The correct anchor distance back from the pool edge is the cover overlap plus the 20" distance from the cover's edge to the anchor. Typically the anchors are about 32" to 38" back from the pool edge.

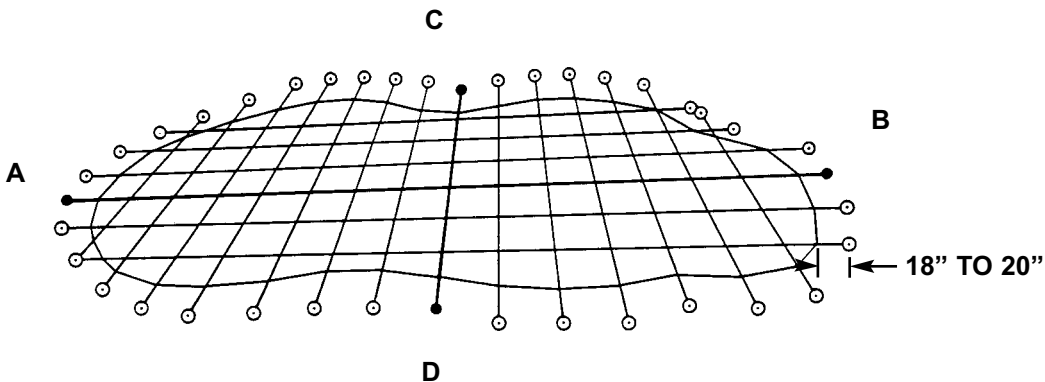

Check to be sure that all the cross webbing and straps are straight. If there are any straps not pulling straight across the cover it may be possible to straighten them by adjusting the tension (by moving the buckles) on the straps perpendicular to them. Check for a uniform overlap around the cover. Tighten straps so that springs are compressed about halfway (approx. 2 1/2" apart) as shown in the diagram below.

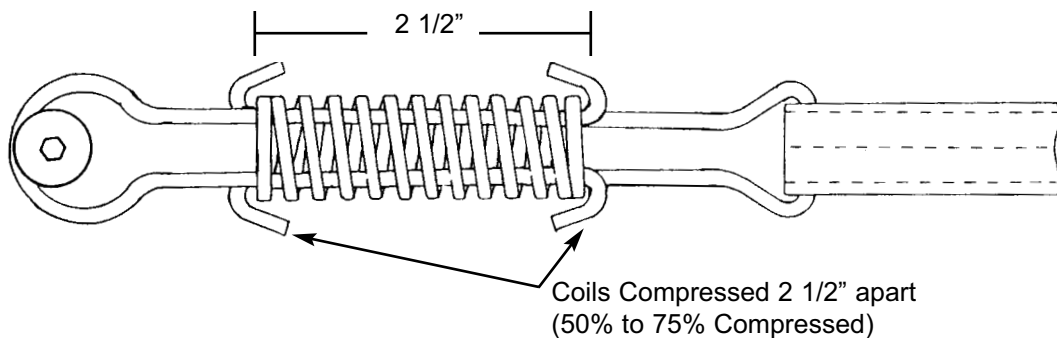

When installing a Solid Cover that requires a pump for water removal: Place pump in the middle of the cover. An additional pump may be required depending on the size and shape of the pool.

Anchor Drilling:

Once you have located proper anchor positions, you can drill holes to accept the anchor shells. Measure the drill bit beveled depth. Then add 2" for pop-up type anchors or 1 3/4" for screw-type anchors. Mark this measurement onto your tamping tool and drill bit with electrical tape or use a drill guide. Drilling dust can be removed with a vacuum or carefully blown out.

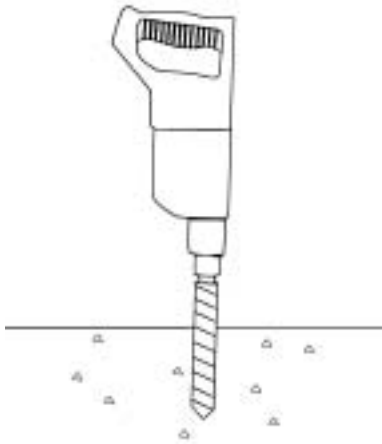

Drill hole with a 3/4" drill bit. The hole depth is 1 3/4" screw type (2" pop-up type) plus drill bit beveled depth.

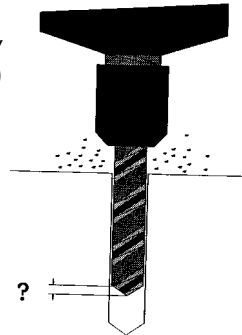

When your anchor hole is properly prepared, the anchor shell can be lightly tamped into position by inserting the tamping tool into the shell and tamping it into the deck with a mallet or hammer. A light Teflon or silicone spray on the tamping tool prior to tamping will facilitate its easy removal. If the tamping tool should become jammed into the anchor, try gently tapping the tool on the sides to loosen it while pulling in an upward direction. For "Pop-Up Style" anchors, properly align the bevel on the tool with the inside of the anchor. Do not force it.

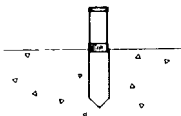

Position the anchor shell above the hole.

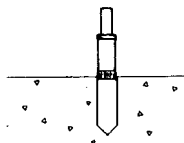

Insert taming tool into the anchor shell.

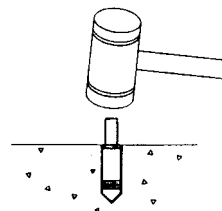

Tap tamping tool gently to set anchor flush with deck.

Fastening Springs to Anchors:

Position the anchor insert in their up position by use of the hex key. Slide the installation rod through the loop end of the spring and position over the end of the anchor head. The elongated tip of the rod should be towards the back of the anchor (furthest away from the pool). The installation rod should now be at an angle towards the pool.

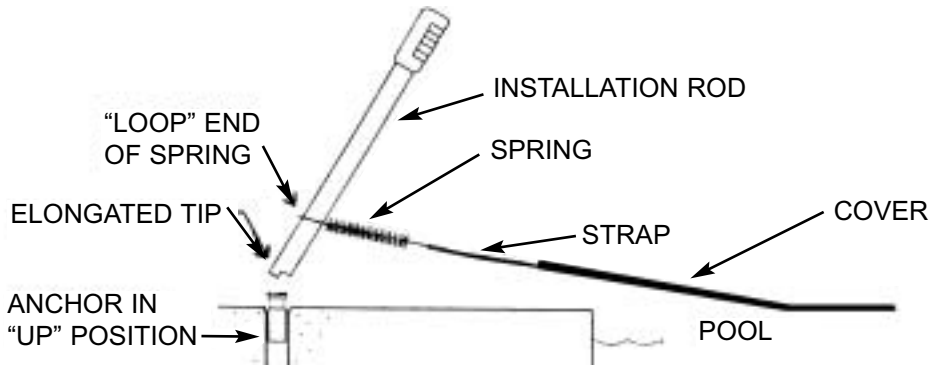

Pull the rod handle away from the pool. The spring will slide down the rod to the elongated tip. This can be facilitated by pushing down on the spring with your foot. The rod may also be lightly sprayed with a silicone lubricant to ease sliding. The spring will slide off the rod and onto the anchor head.

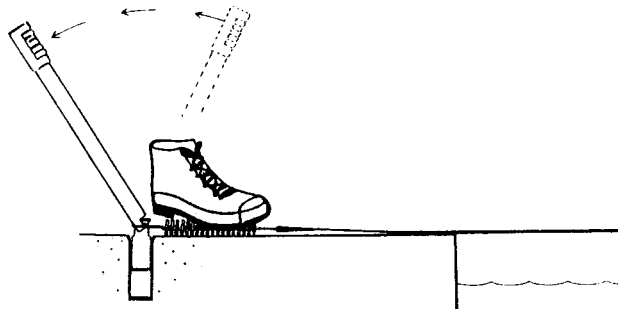

The cover should be "drum tight". A loose cover will allow "wind-whipping" which may result in coping wear on the fabric around the perimeter of the cover. At the time of initial installation it is suggested that the cover be set extremely taut by adjusting the strap buckles to a position where the cover tension will have the spring coils almost touching. As the cover stretches slightly the tension will lessen and the springs should adjust to their normal position. The cover tension should then be checked periodically. The spring coils should be compressed about 2 1/2".

Removing Springs From Anchors:

Insert installation rod over anchor ahead so that extended tip of rod fits into space inside looped end of spring (the pool side of the anchor). See step 1.

Rotate the rod a half turn so that the extended tip slides between the anchor and the end of the spring furthest away from the pool. See step 2.

Tilt the rod towards the pool. Step 3. The spring will slide up the rod, releasing the spring from the anchor head. As the tension has now been removed, the spring at the opposite end of this strap can now easily be removed from the anchor head by hand.

STEP 1

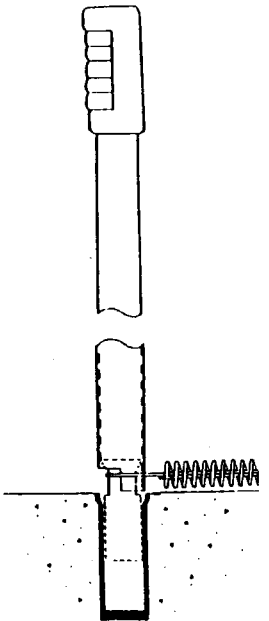

STEP 2

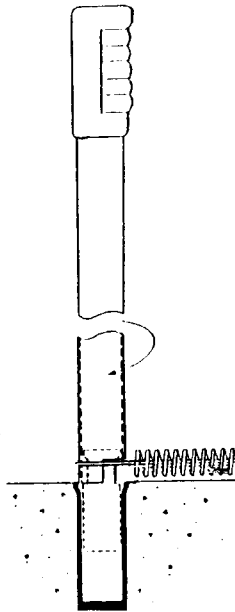

STEP 3

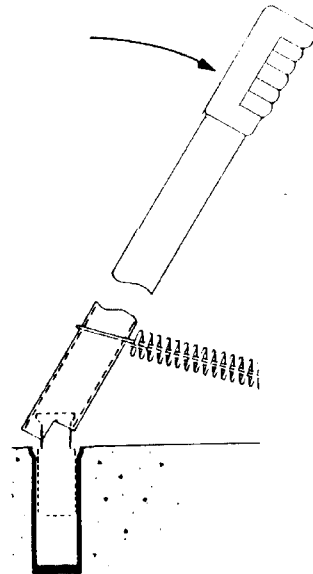

Hardware:

1. **BRASS ANCHORS** - FOR STABLE SURFACES SUCH AS CONCRETE, MORTARED BRICK OR PATIO STONE DECKS

For these and other stable anchoring surfaces, anchors can be installed by simply drilling a hole with a rotary hammer drill camping the anchor shell into the hole; and inserting the anchor insert. A carbide tipped drill bit is often used for drilling. Diamond tipped bits are available for longer life, quicker drilling, and more precisely round holes.

For low grade concrete decks and decks with veneer coatings, spalling or chipping may occur when drilling. It is advisable in these cases to use a slow-speed drill for the initial drilling, followed by the hammer drill setting to complete the hole. Brass anchor flanges are available (for screw type anchors only) to help “cover” chipping around the anchor edges.

STANDARD “SCREW” TYPE ANCHOR

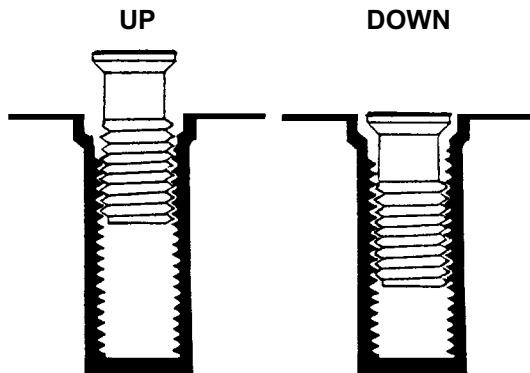

Threaded to rotate up & down

OPTIONAL “POP-UP” TYPE ANCHORS

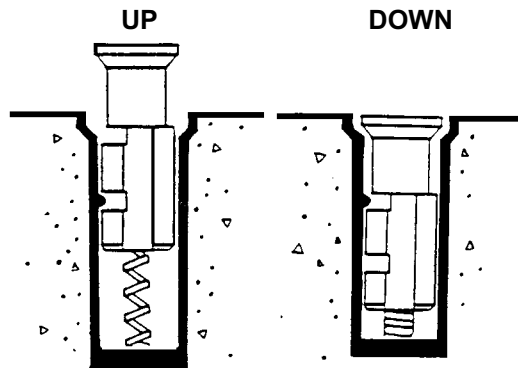

1/4 turn with spring insert to release or set into position

note: to facilitate smooth operation it is recommended that anchor inserts be removed each spring and fall and shells flushed out of any dirt. The brass inserts may also be lightly coated with a silicone or Teflon spray to ensure smooth operation. **Do not use oil or grease!**

2. **PIPE ANCHORS** - FOR UNSTABLE SURFACES SUCH AS LOOSE BRICKS, PATIO STONES, AND LANDSCAPE AREAS

For areas with unstable decking it is recommended that Meyco Pipe-anchors be used to properly anchor the cover. Pipe anchors are 18" long aluminum tubes with a brass screw-type anchor permanently embedded into one end. Pipe anchors can be installed by pre-drilling a 1" hole into the ground and through loose bricks or patio stones when necessary. Place a block of wood over the top of the pipe anchor assembly (or use a rubber mallet) to gently tamp into place.

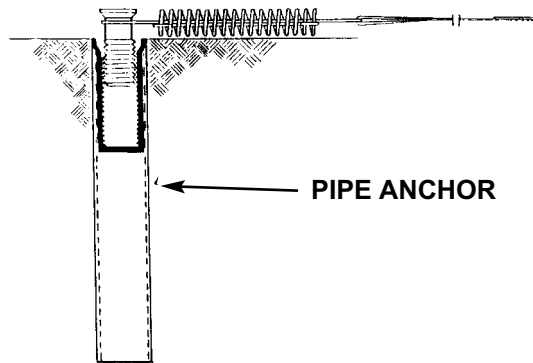

3. **LAWN STAKES** - FOR GARDEN AND LANDSCAPE AREAS

The aluminum pins are 1/2" round, 18" long, with a head at the top to hold a spring. Lawn stakes do not provide the same degree of safety as a standard or pipe-anchor assembly and should not be used for more than 20% of the anchoring points around a pool. Lawn stakes should also never be placed at opposite ends of the same strap.

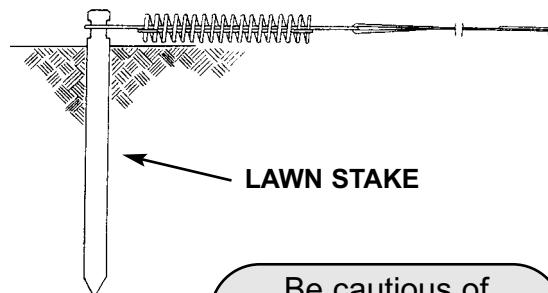

Be cautious of underground piping or electrical wiring.

Hardware Cont.:

4. WOOD DECK ANCHORS - FOR STURDY WOOD DECKS

Meyco wood deck anchors may be used to anchor covers with wood decks capable of supporting the anchor. It is up to the installer to determine if the decking is of sufficient thickness and strength to support the tension of the cover and the attachment of the anchor.

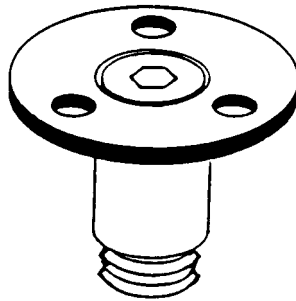

The anchor should be properly countersunk into the decking by drilling two holes into the wood- First a 2" x 1/8" "countersink" is necessary to accept the top flange. This can be drilled with a "hole saw" drill bit. Secondly a 3/4" hole is needed to accept the body of the anchor itself using a conventional drill bit. A 2" Forstner Bit is recommended.

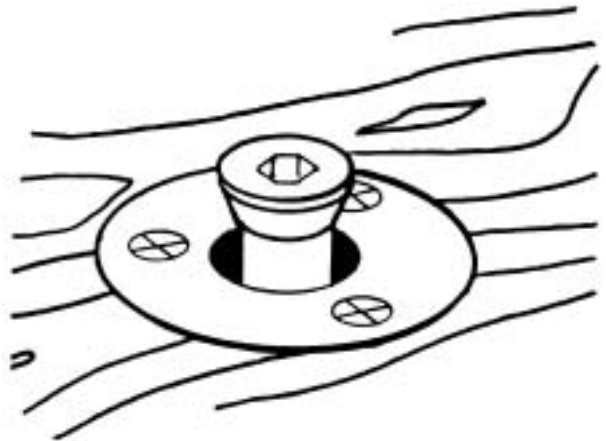
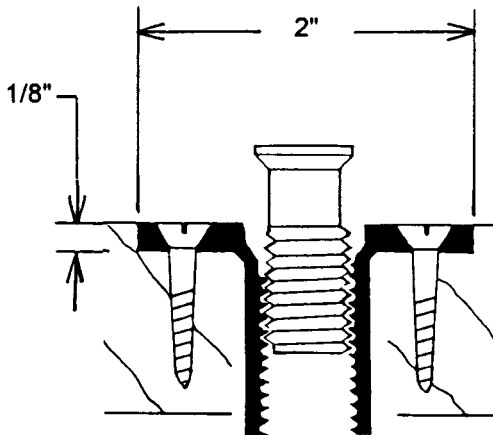

When drilling to install numerous wood deck anchors; a "Forstner" Bit will facilitate quick drilling of the 2" shallow flange countersink hole. It is available from Harbor Freight Tools at (800) 423-2567.

5. WALL ANCHORS - FOR ANCHORING INTO VERTICAL AREAS

When areas of raised decking or rocks do not allow for normal anchoring, wall anchor/ eye-bolt sets may be used to attach the cover directly to the wall. Wall anchors are inserted into a 3/8" hole drilled directly into the raised wall or rock area. The eye bolt is then screwed into the anchor forcing the wall anchor to expand to a tight fit into the wall.

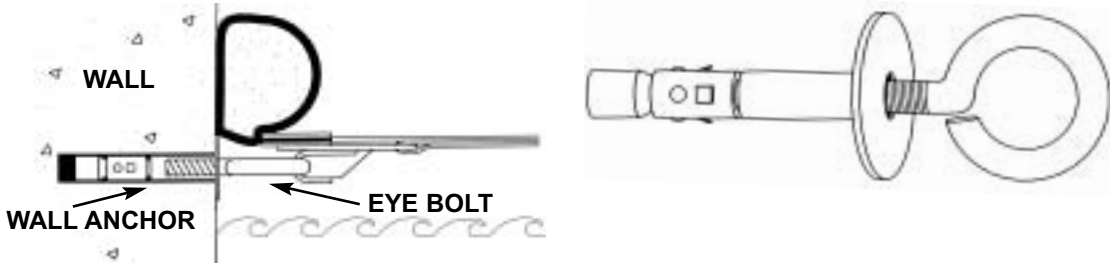

6. Extension Straps

Extension straps may be used when the standard 20" long strap is not long enough to extend across a decking surface to reach the desired anchoring location. Extension straps are available in lengths of 4' 6' and 8'. Extension straps in excess of 8' are not recommended as they could lead to wind whipping and premature cover wear. More than 20% of extension straps on a cover should be avoided.

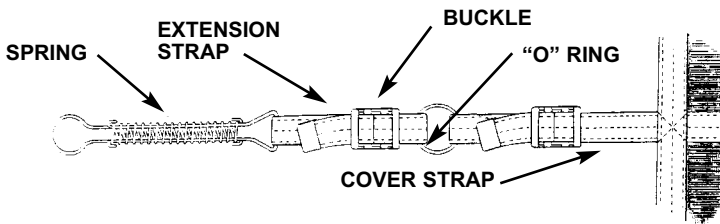

7. YOKE STRAPS

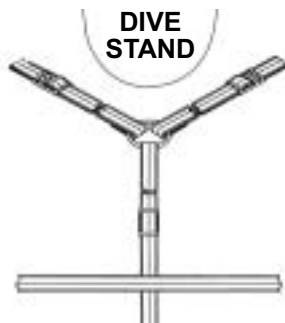

Use And Care of Your Meyco Cover:

1. Never allow the pools water level to fall below 18" from the main deck level. A low water level will result in cover and/or spring damage during periods of snow accumulation. This damage will not be covered under the warranty.
2. Do not walk on the cover except in an emergency situation. It should not be jumped upon like a trampoline. Walking or jumping on the cover may result in damage to the cover not covered by the warranty.
3. The pool water must be properly chemically treated when closing the pool for the winter. The water chemical level should be checked in early spring or when there is any period of warm temperature. Proper adjustment of chemicals should be made if necessary.
4. Abrasion strips are sewn to the cover to protect against normal coping wear. The cover should be kept drum tight to help lessen the chance of excessive wear not covered under the warranty.
5. It is the responsibility of the installer to, when necessary, add protective padding to sharp corners or very rough areas of the pool. Vinyl padding or carpet remnants may be used for such protection.
6. The cover should be folded and stored in its storage bag when not in use. Leaves and debris should be removed. The mesh cover material does not require that it be scrubbed down or powdered prior to storage.
7. Solid covers should be cleaned with a mild detergent and dried before storing.
8. The cover should be stored in an area free of rodents.
9. Always completely remove the cover when using the pool. Never swim in the pool with the cover partially installed.
10. Check the cover periodically to be sure the cover is secured drum-tight on the pool. Adjust the buckle positions to achieve the proper tension.
11. Be careful not to drag the cover on decking or over the cover springs. Tears resulting from mishandling will not be covered under the warranty.
12. Do not operate a barbeque grill in the proximity of the cover as sparks or hot ash may settle on the cover and result in small burn holes.